

ILLUSTRATED  
LIST OF PARTS  
FOR  
CLASS 331K MACHINES  
(Nos. 331K1 to 331K6)



\*\* A Trademark of THE SINGER MANUFACTURING COMPANY

From the library of: Diamond Needle Corp

86005

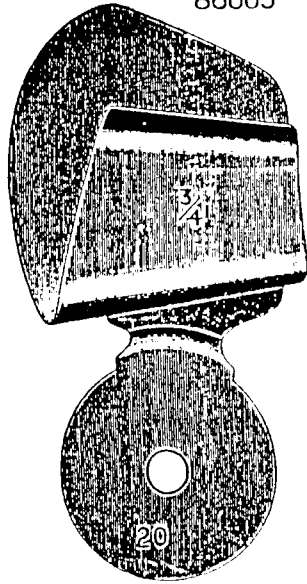

86008

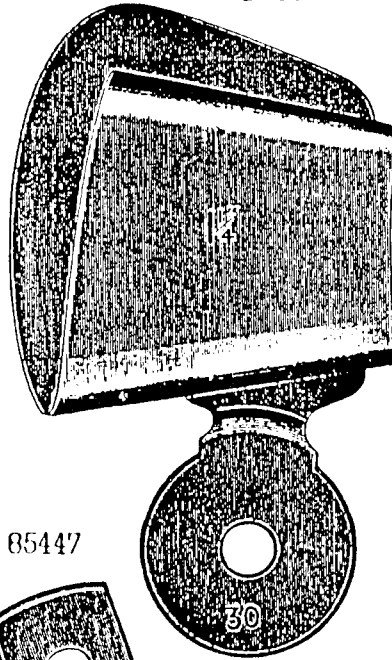

86010

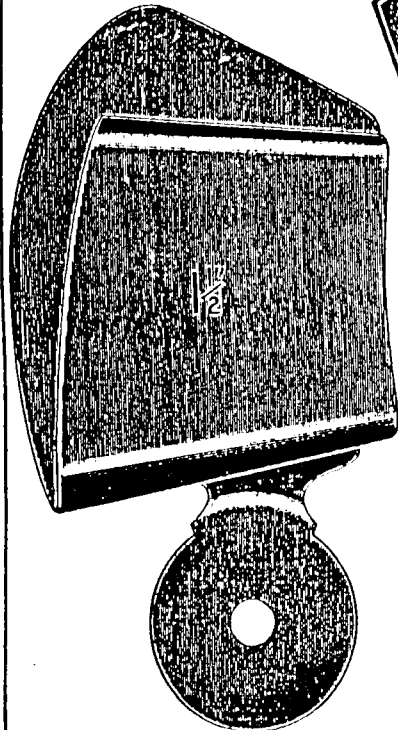

85447

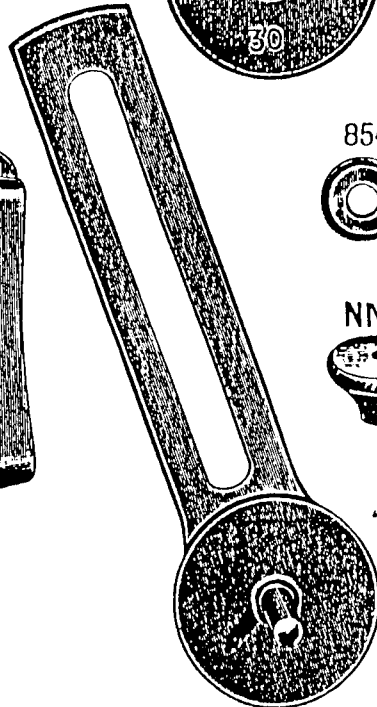

85448



NN40



From the library of: Diamond Needle Corp

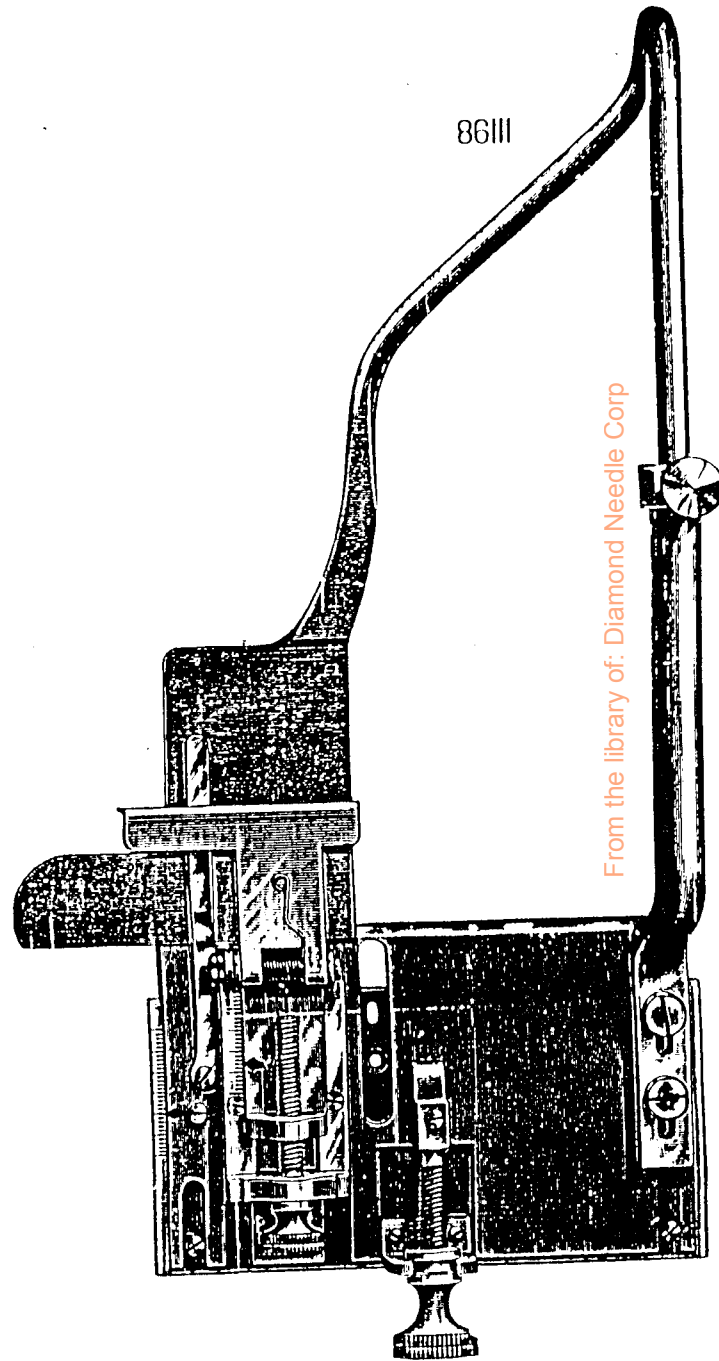
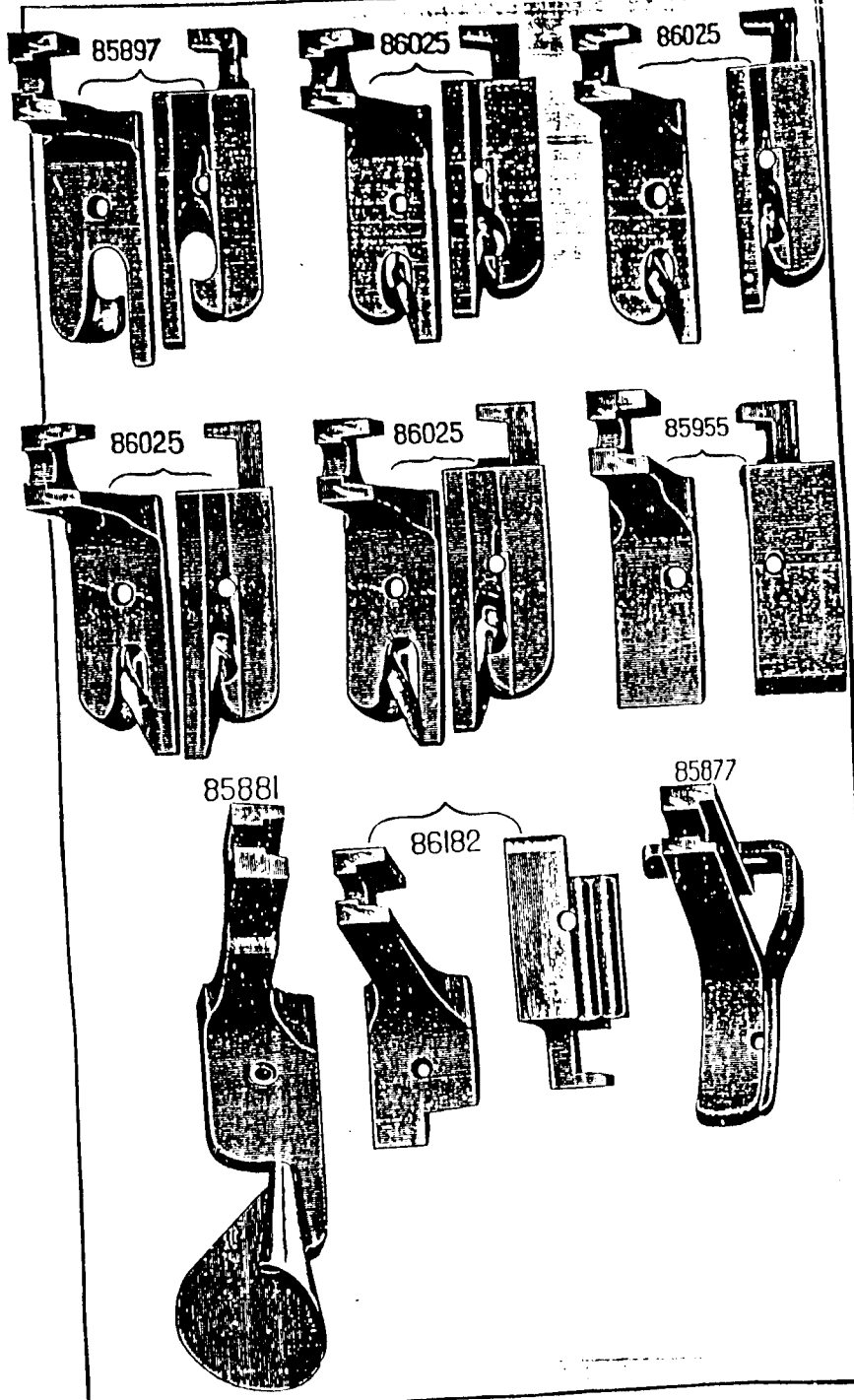

From the library of: Diamond Needle Corp

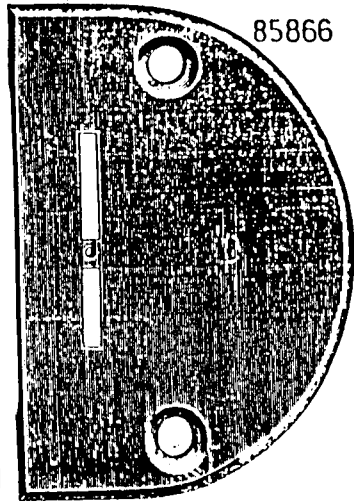

85866

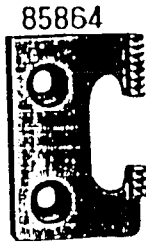

85864

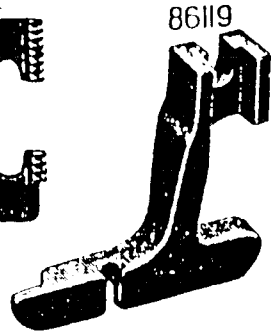

86119

86120

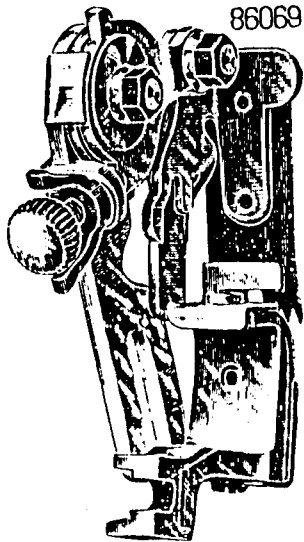

86069

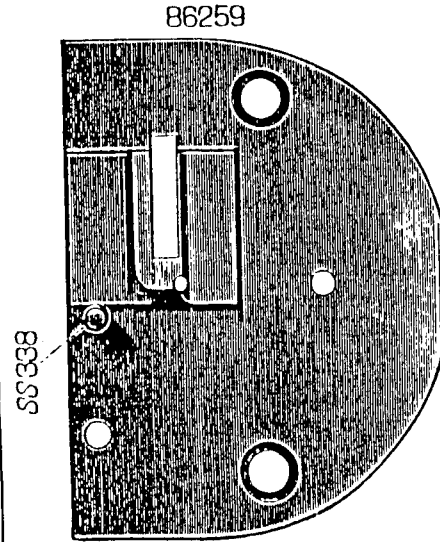

86259



86253

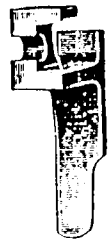

86254

SS 338

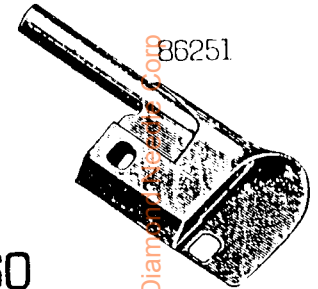

86251

86260

86252

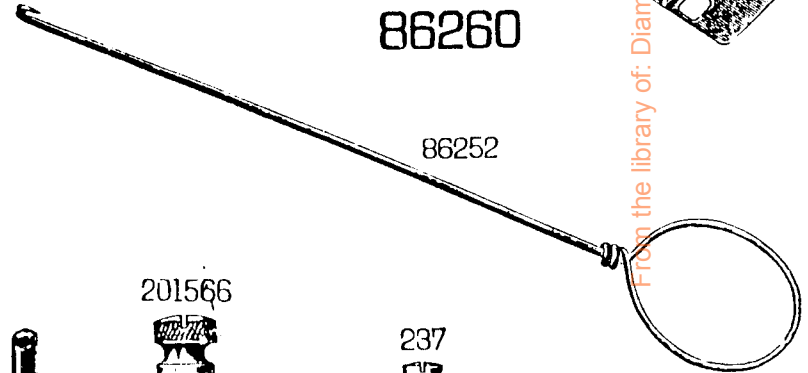

201566



237



86255



86258

86256

759



86257

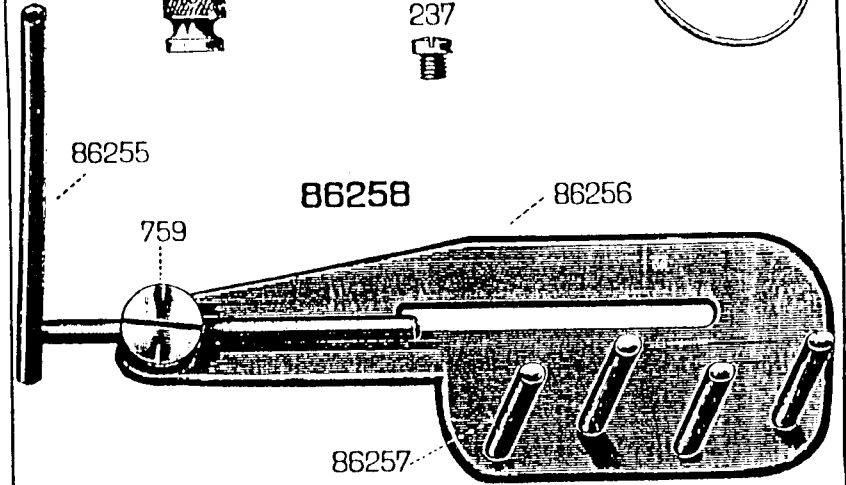

From the library of: Diamond State Library

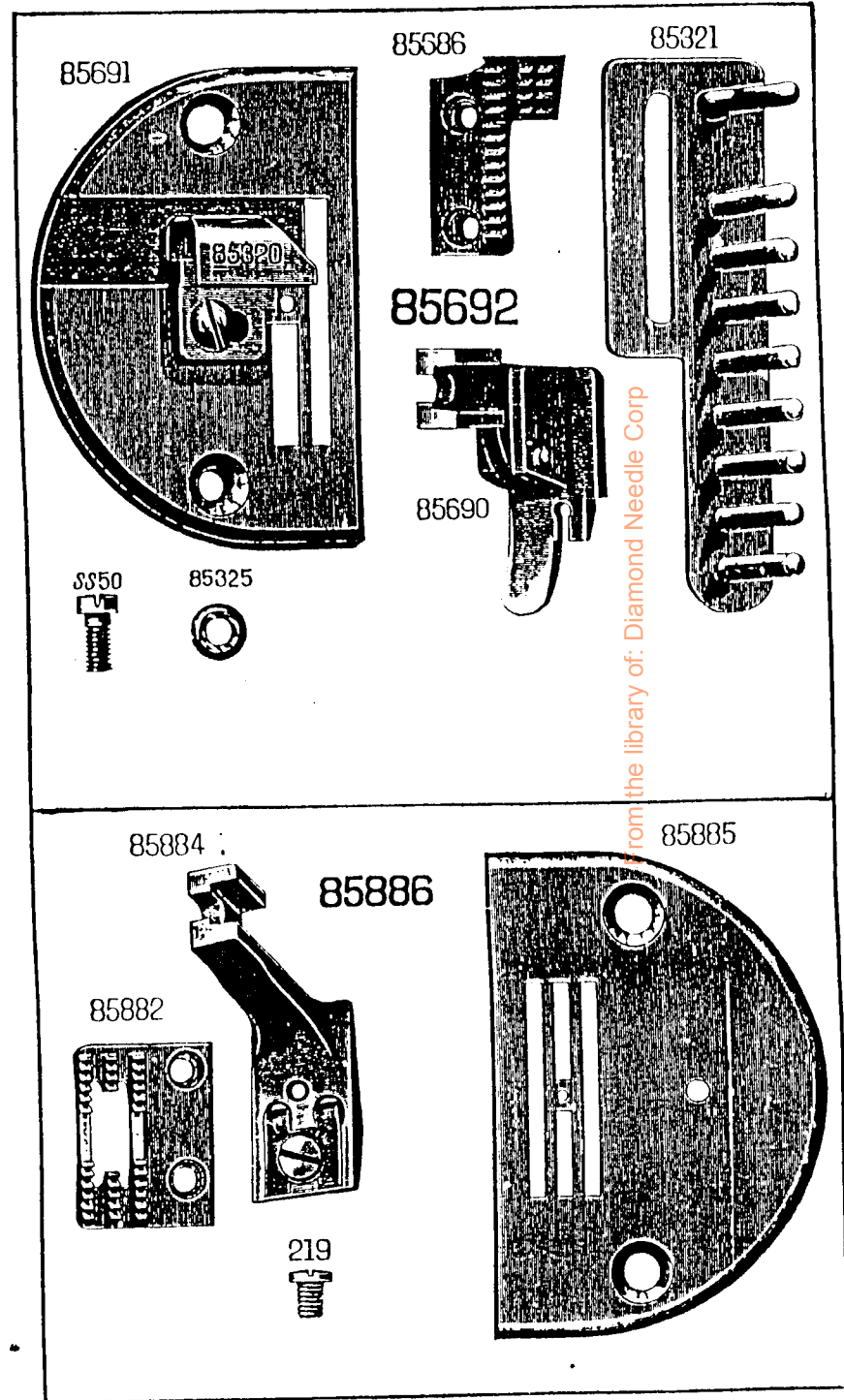
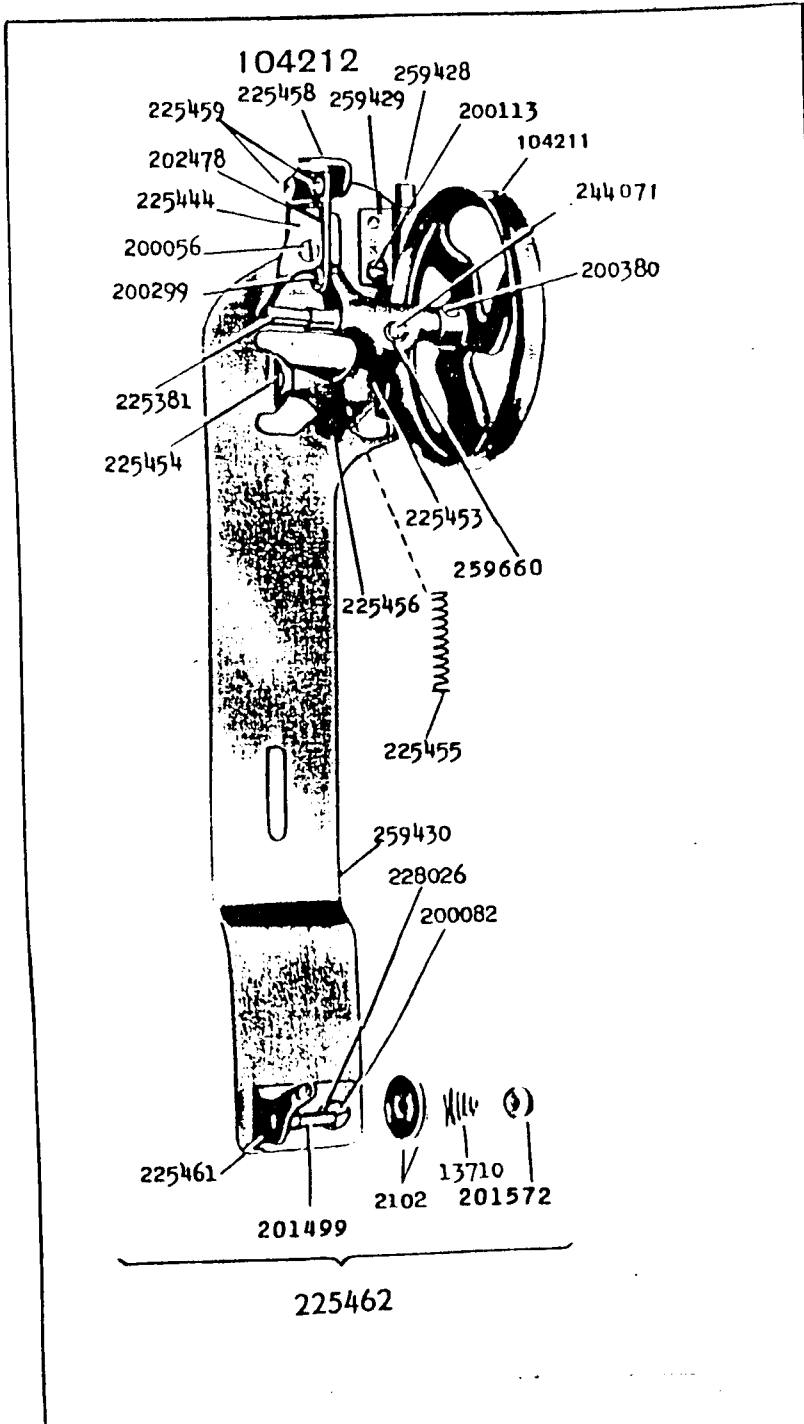

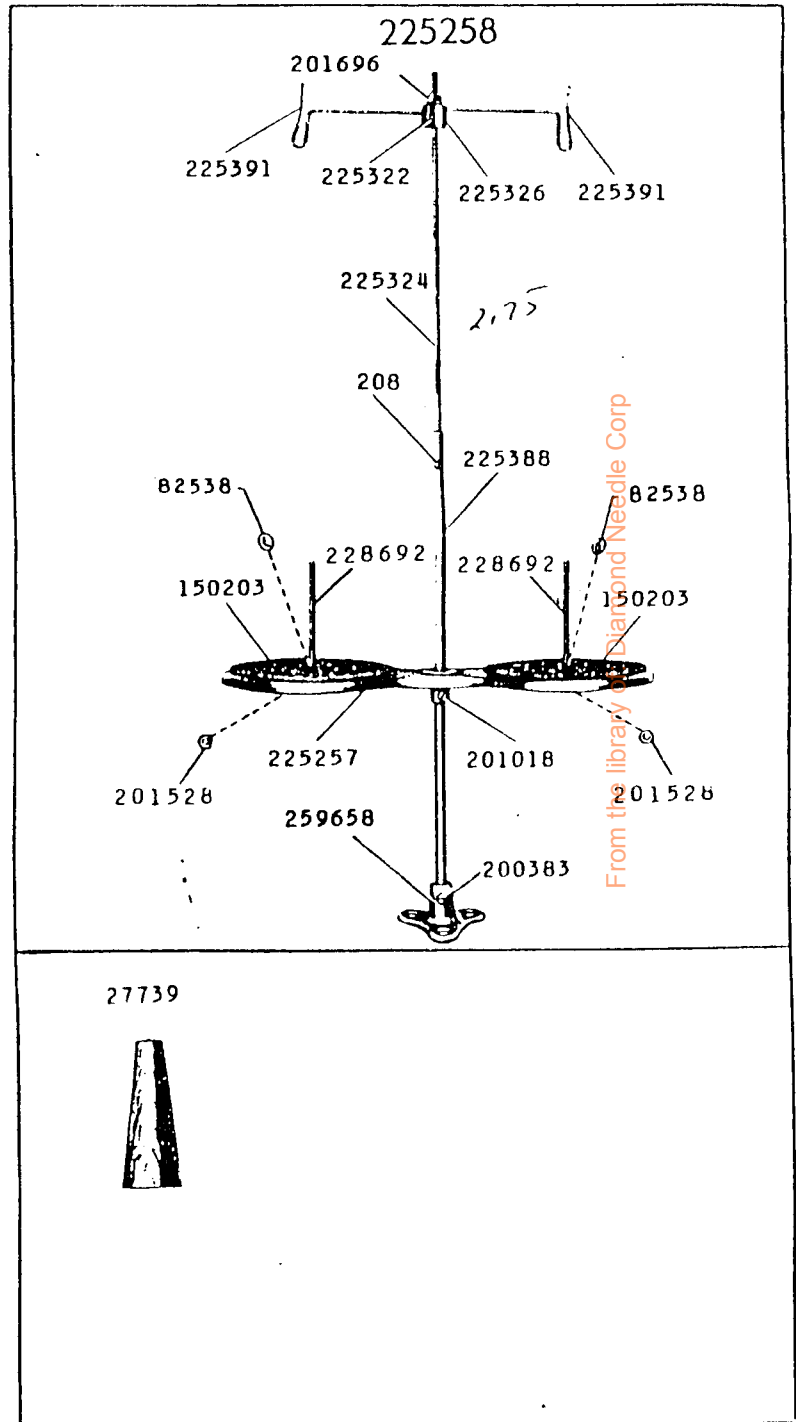
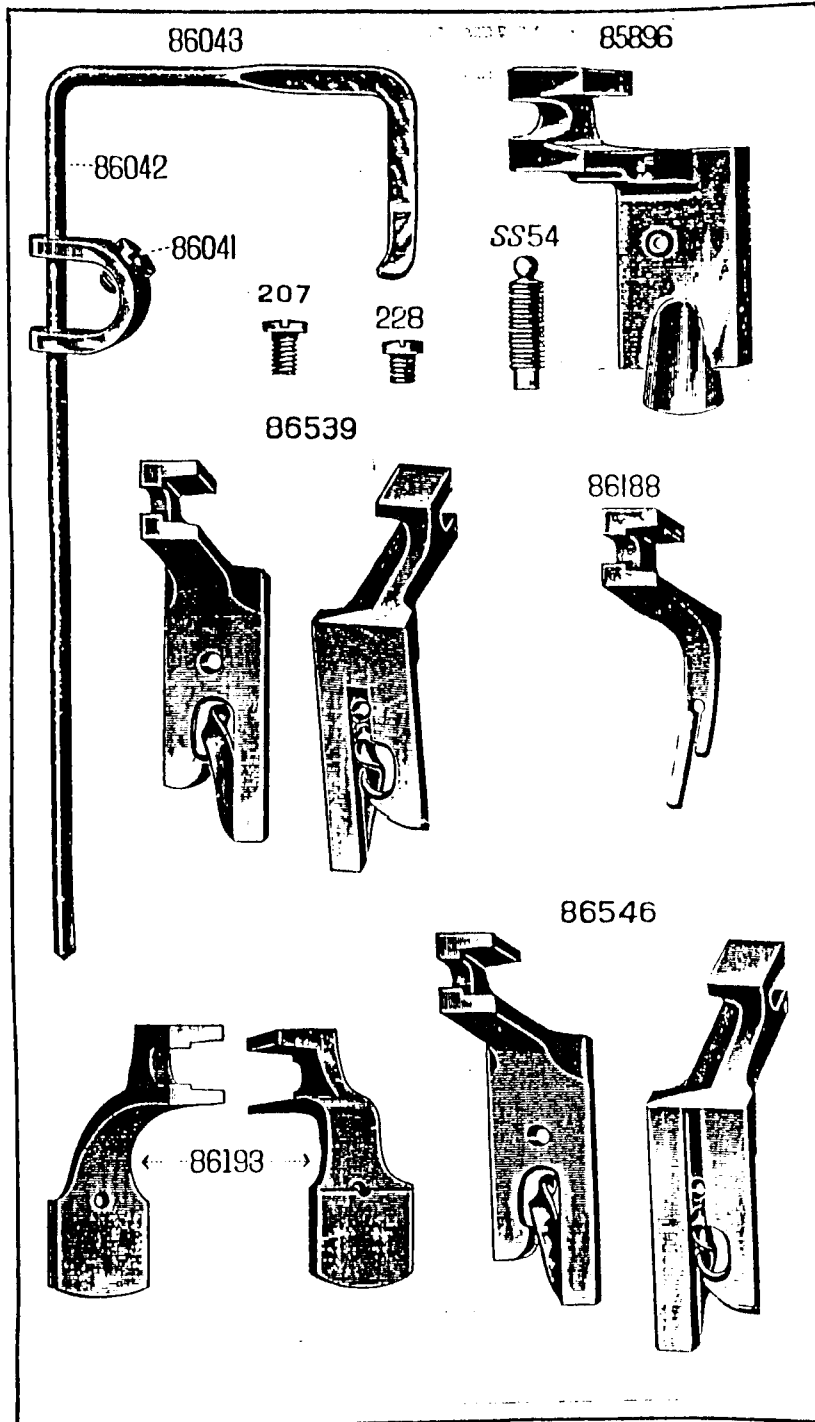

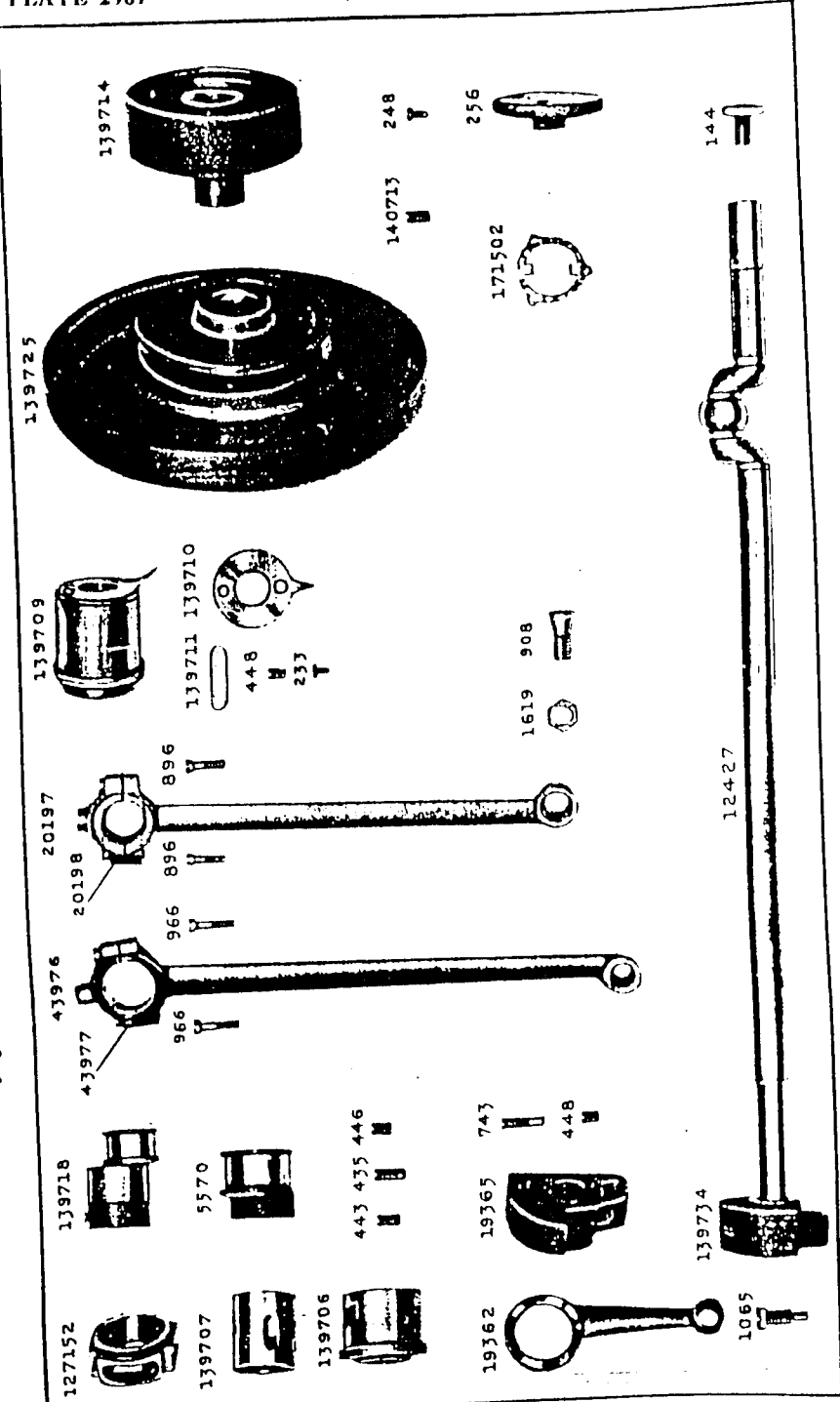

250 / 26P18

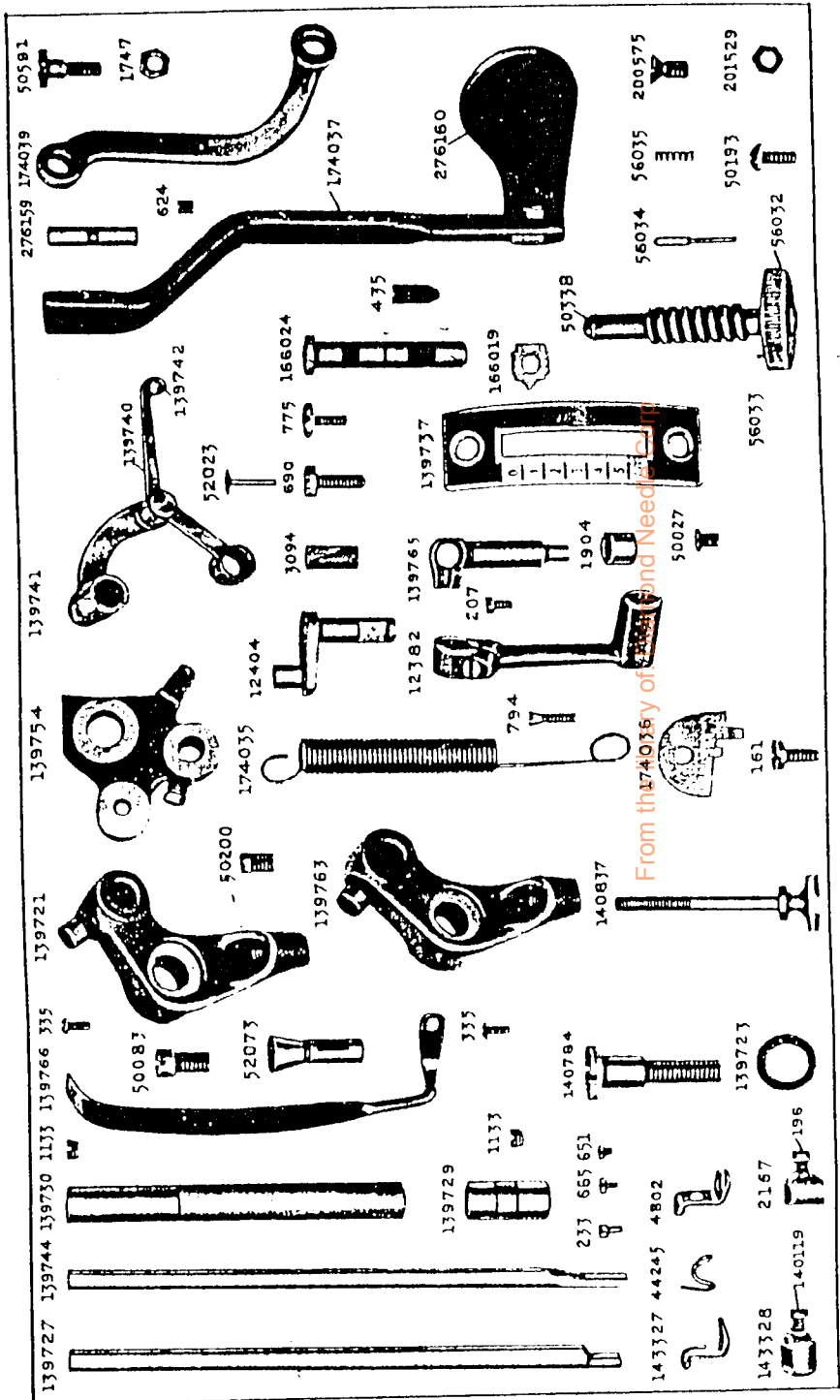

From the 1740316y of Sand Need

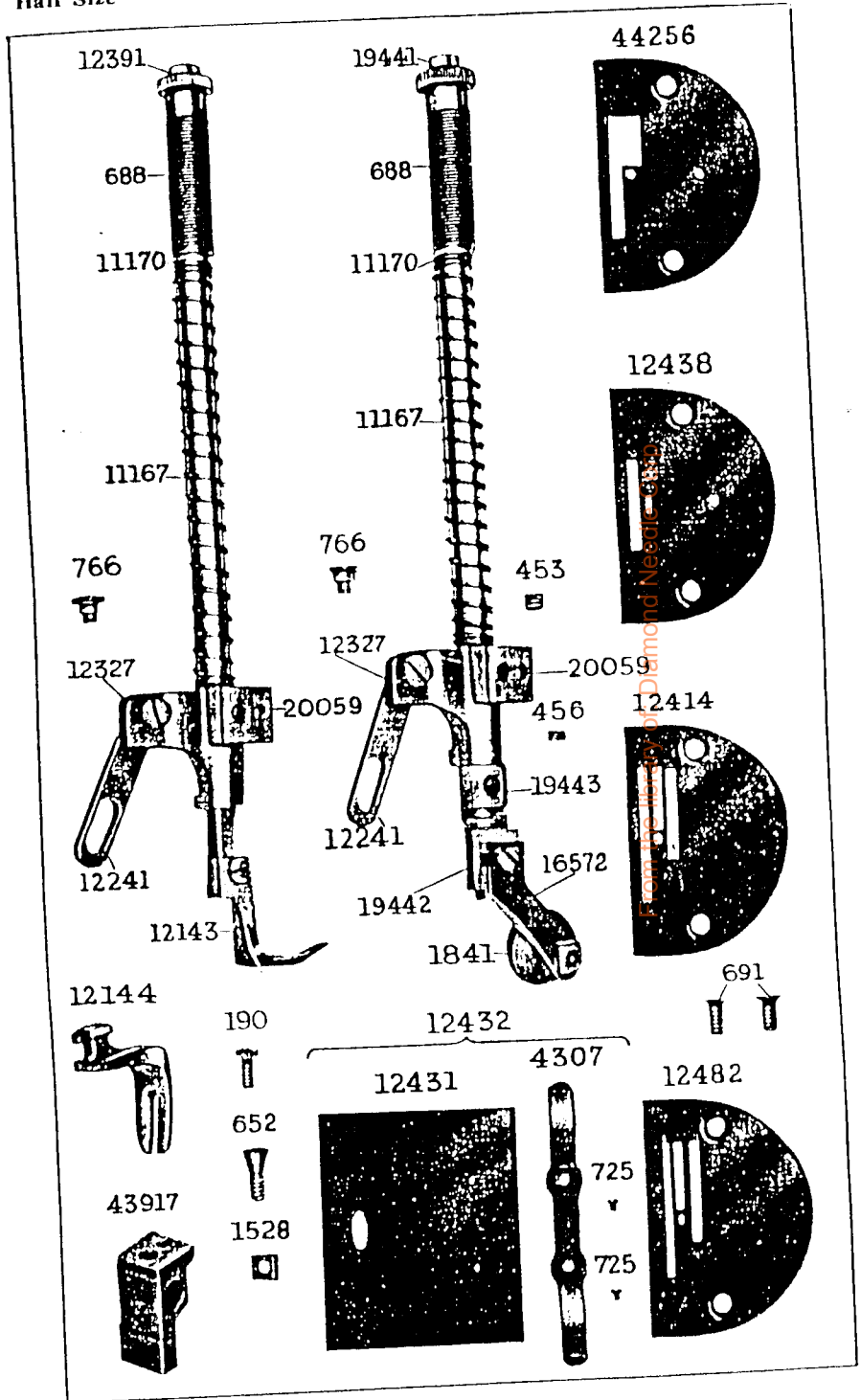
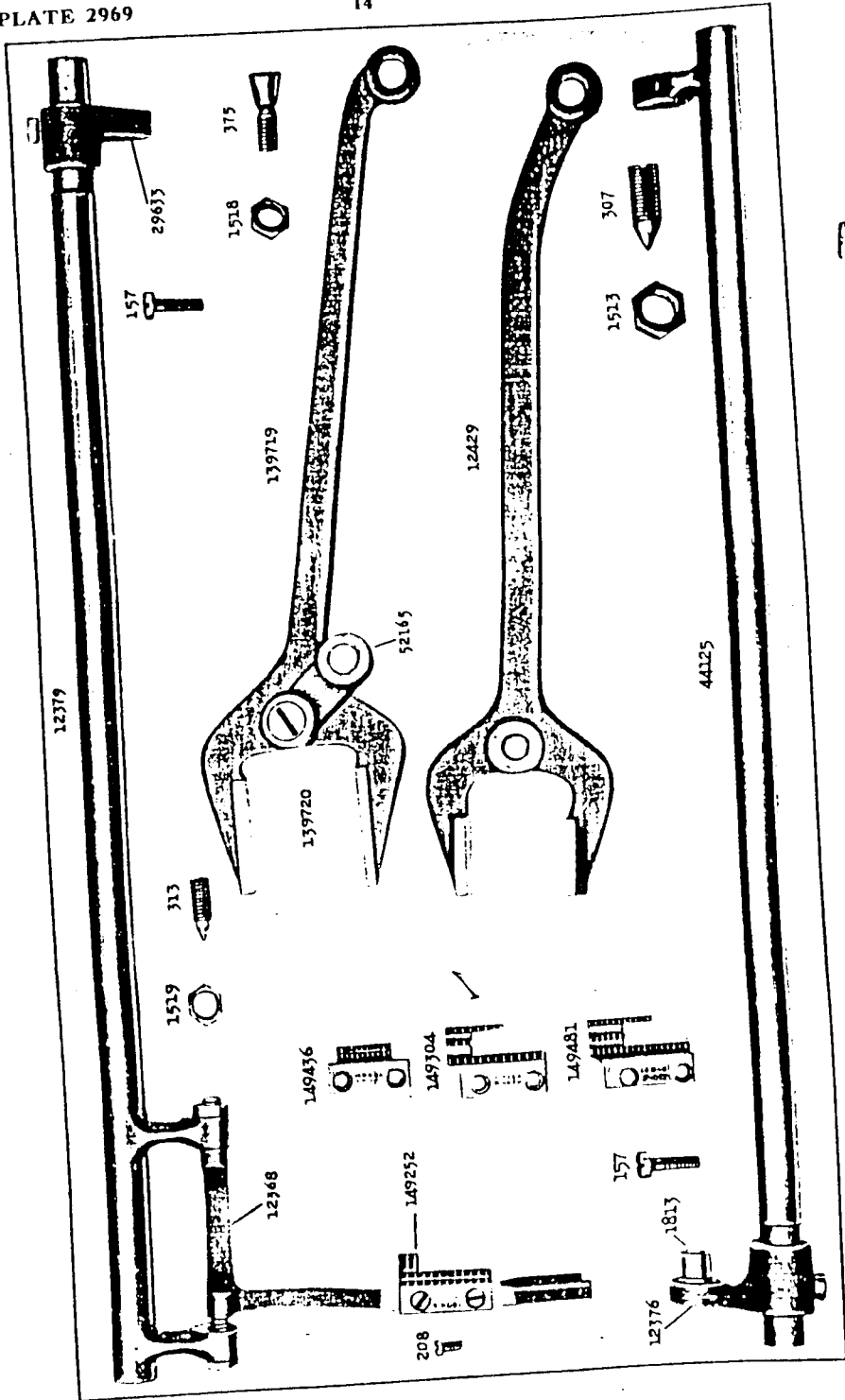



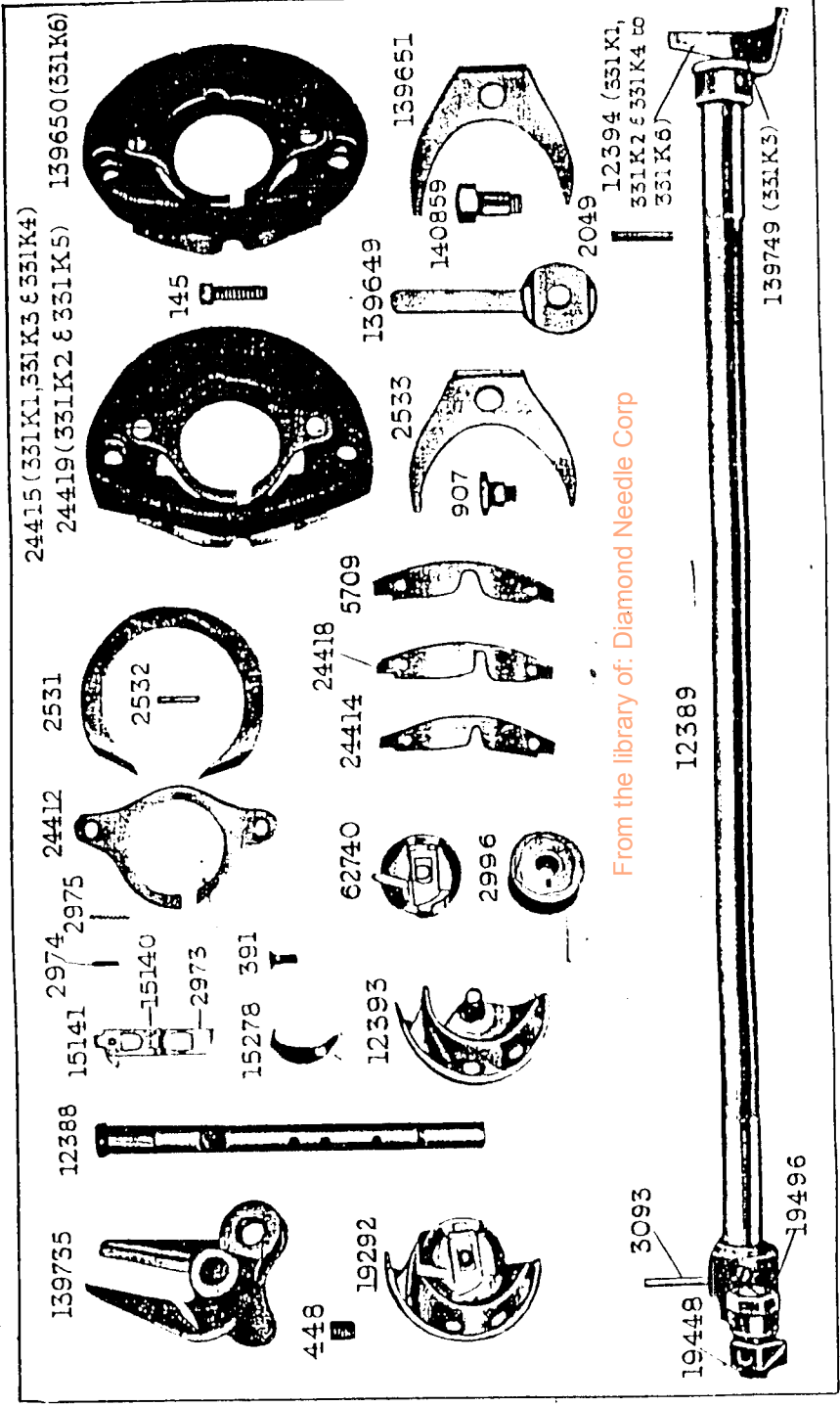
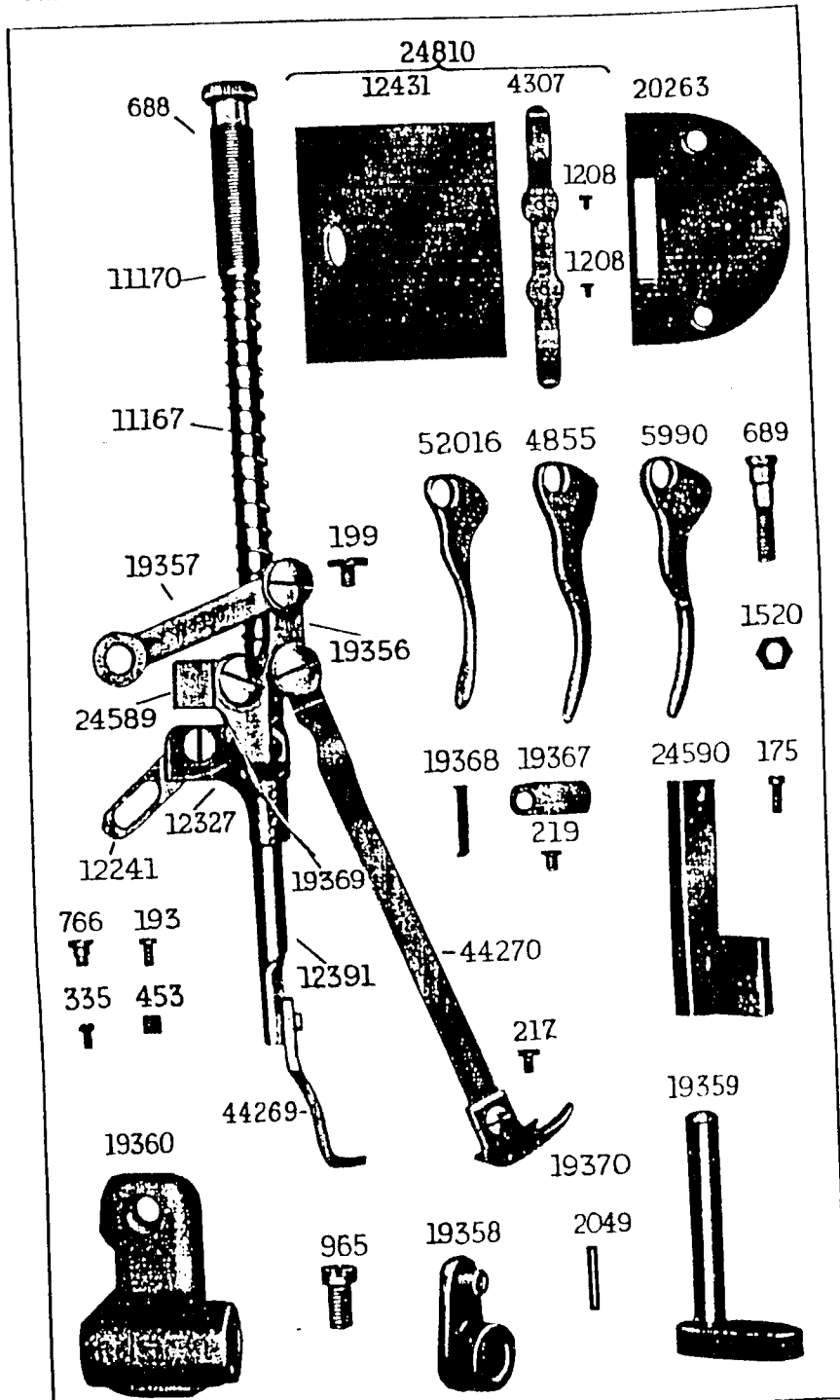

From the library of: Diamond Needle Corp

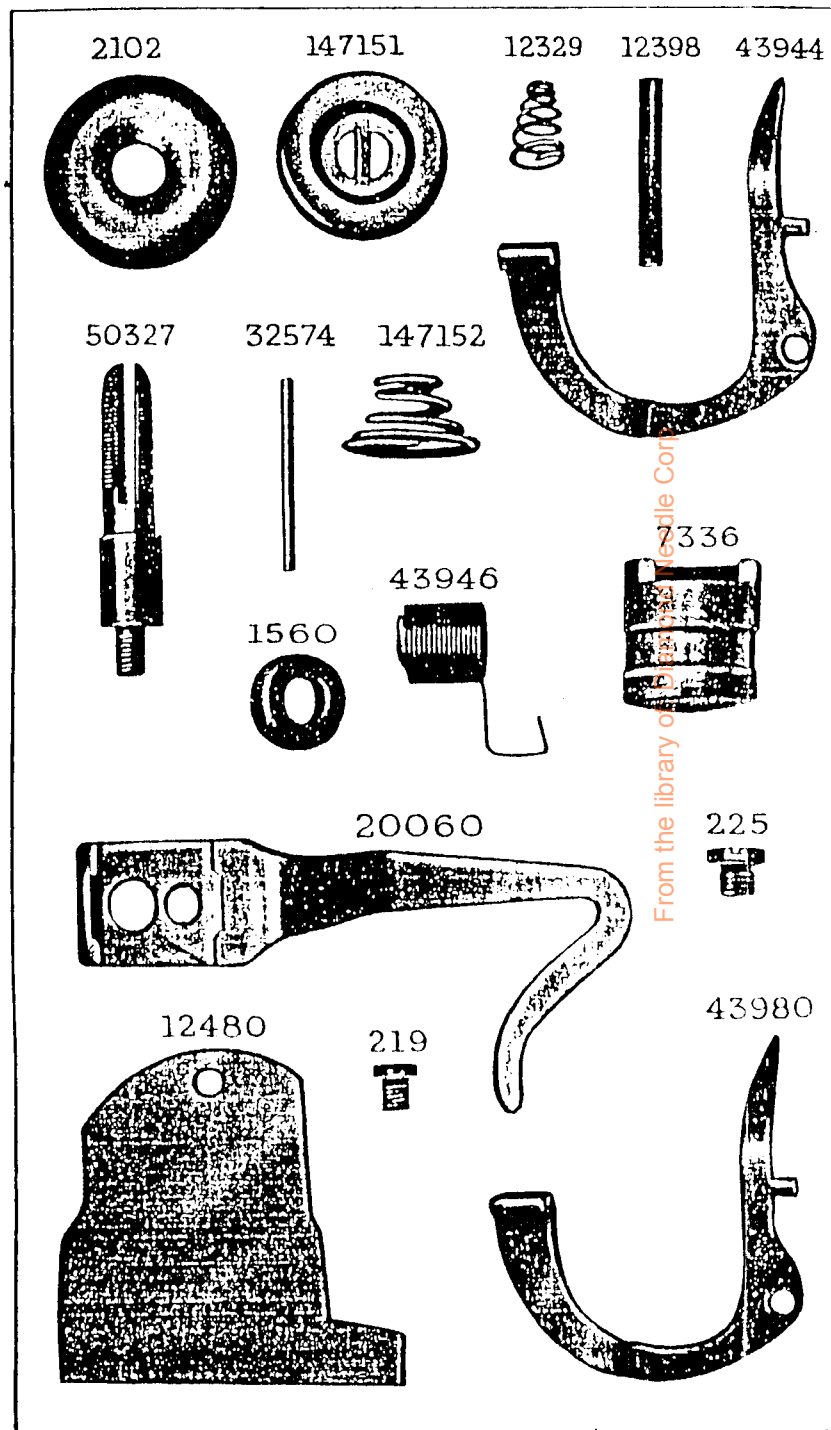
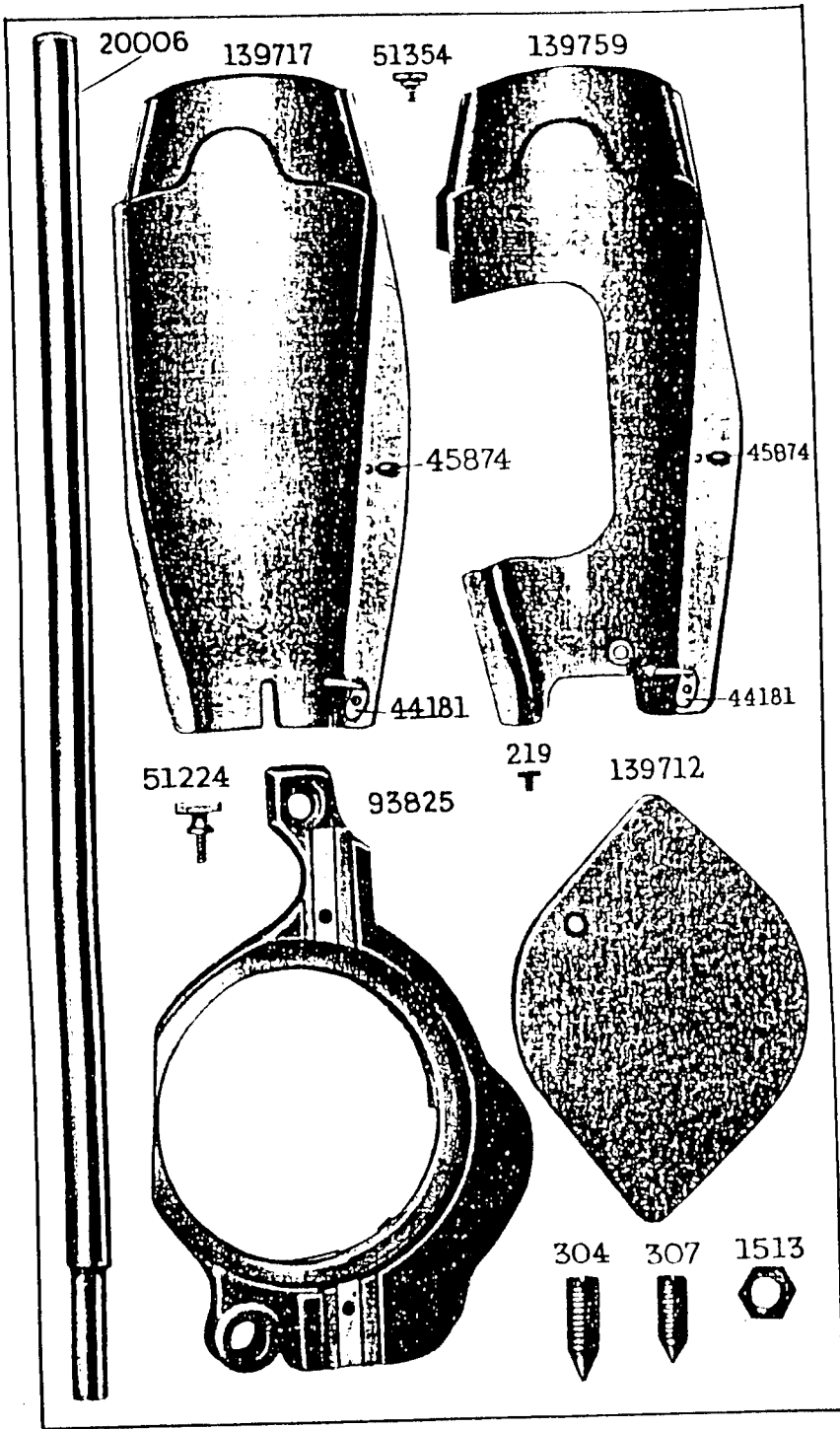

93823 93390 93391 SS340 243 SS339



44102 61 93826 93827

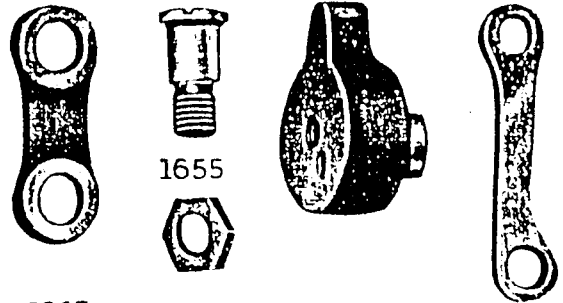

1655



2265



SS79

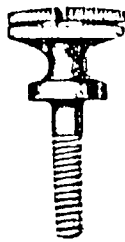

SS353



999



453



2254



2256



240



183



93828



3114

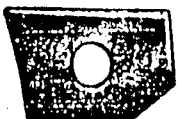

151



2255



139702 139704 12454 24131 99627 52184

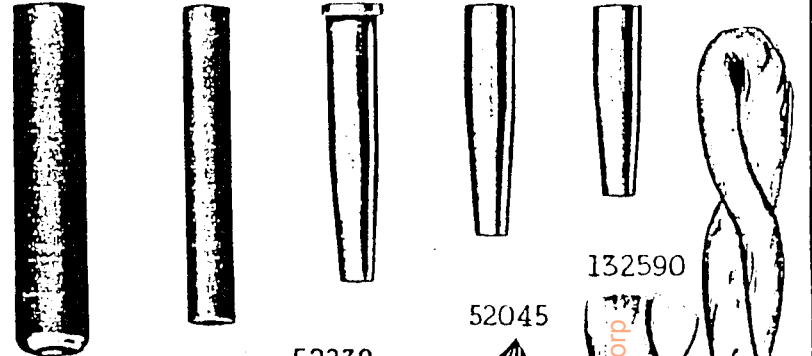

52239



52454

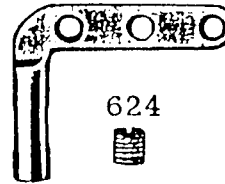

624



8879

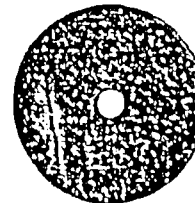

52045



132590



From the library of: Dry End Neer Corp

8582



854

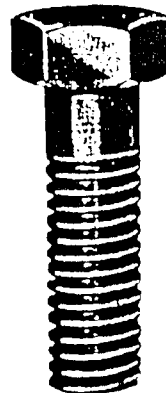

748



226



457



1266



591



592



662



1053



12424



1518



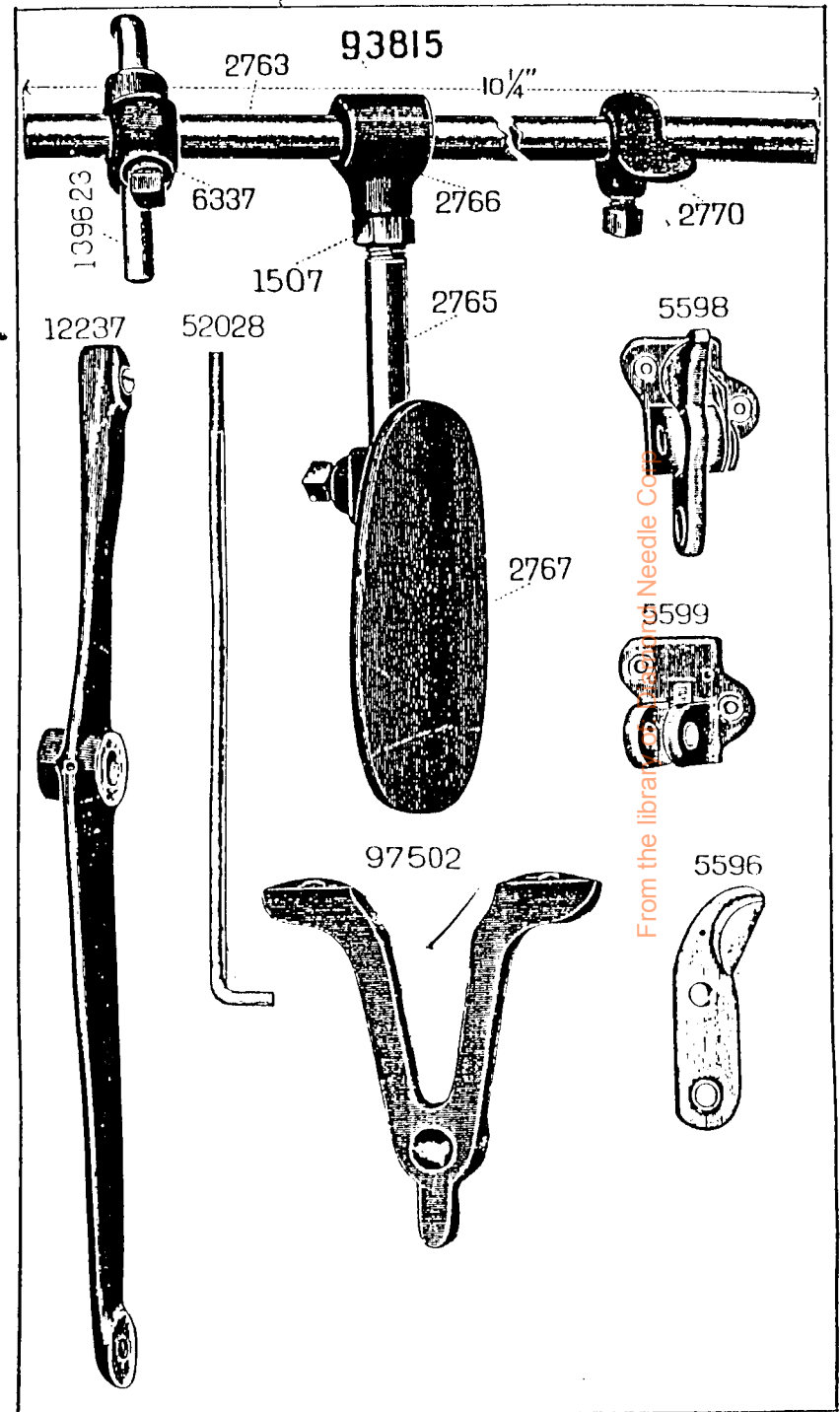
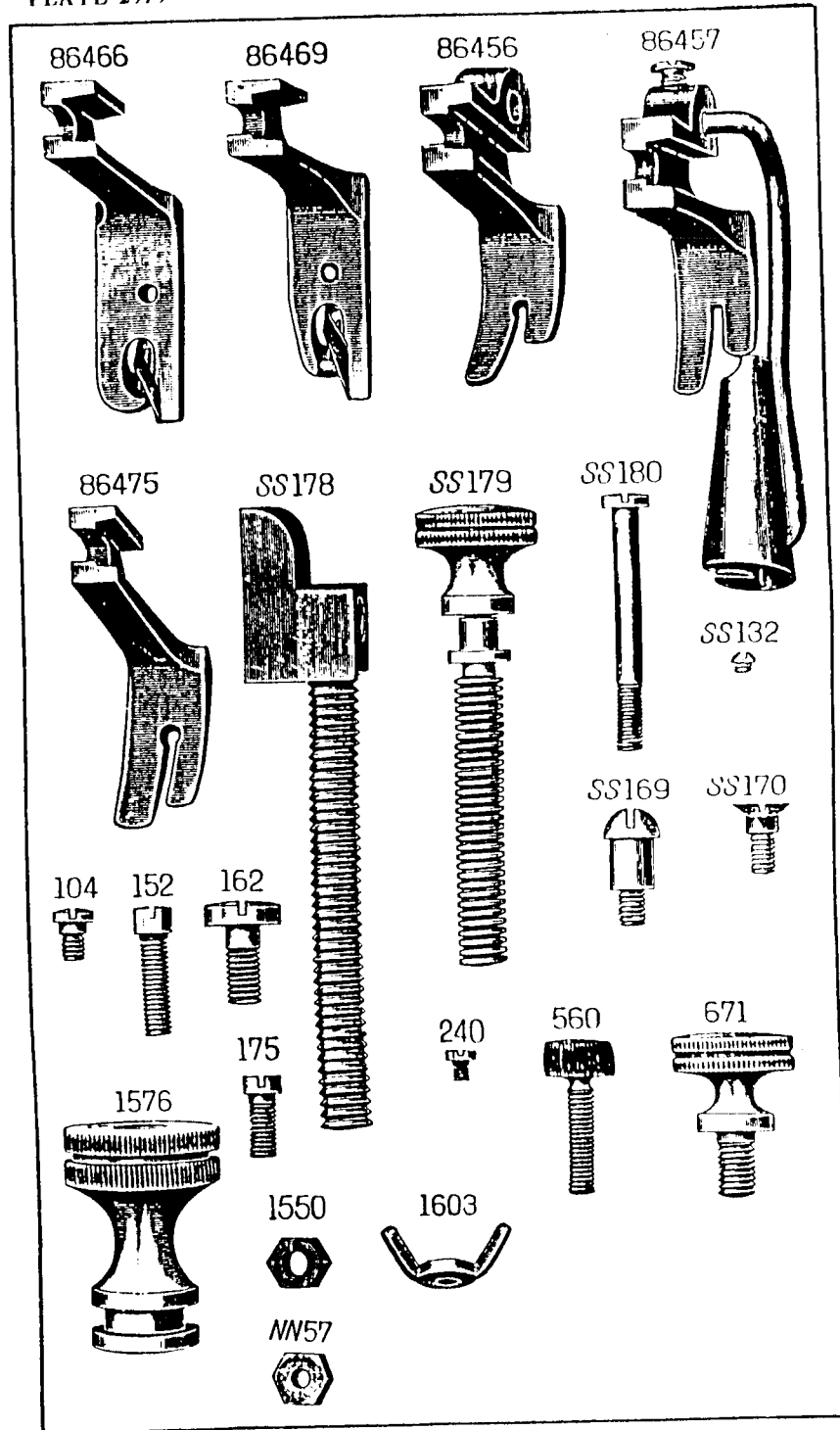

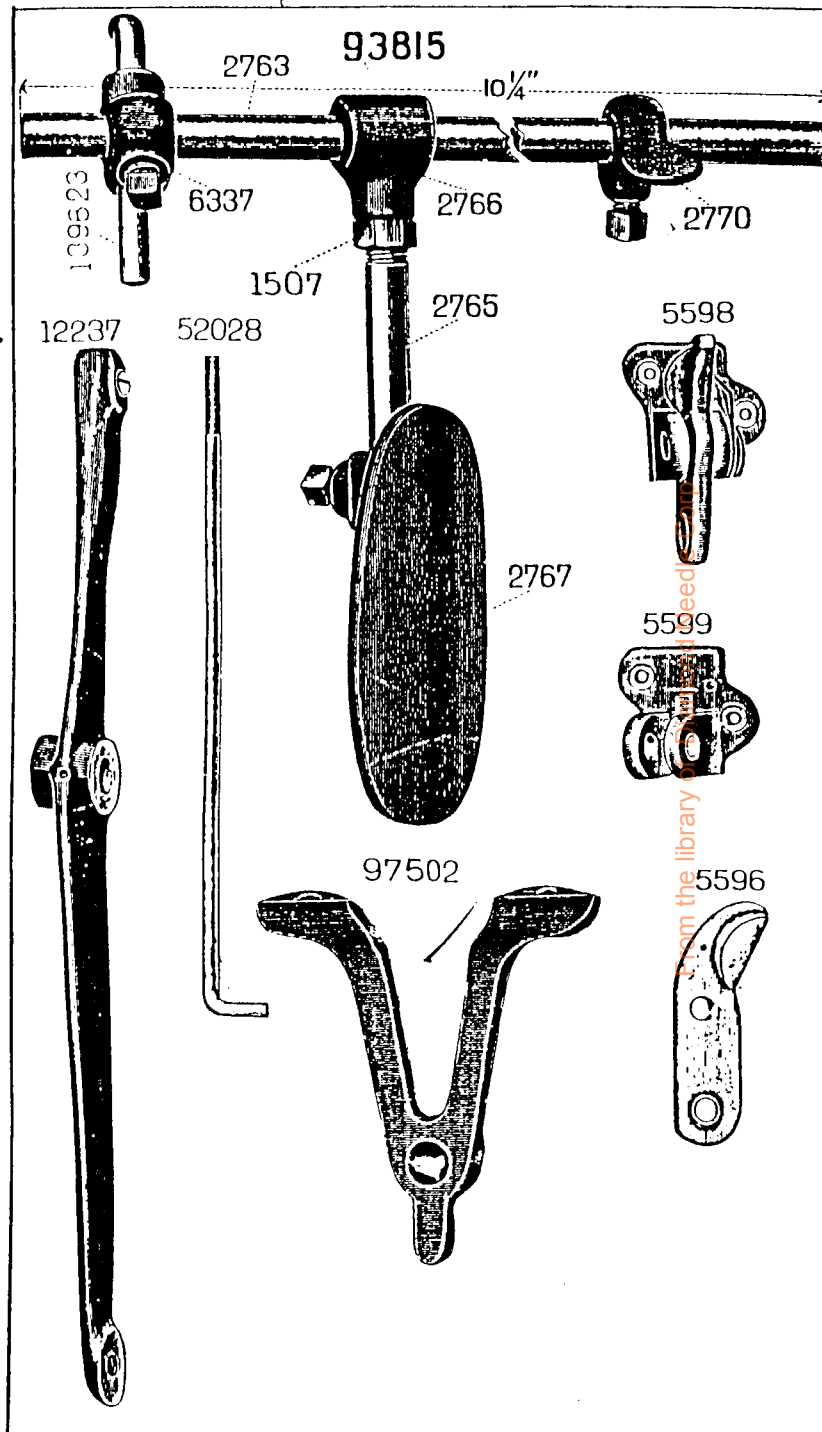
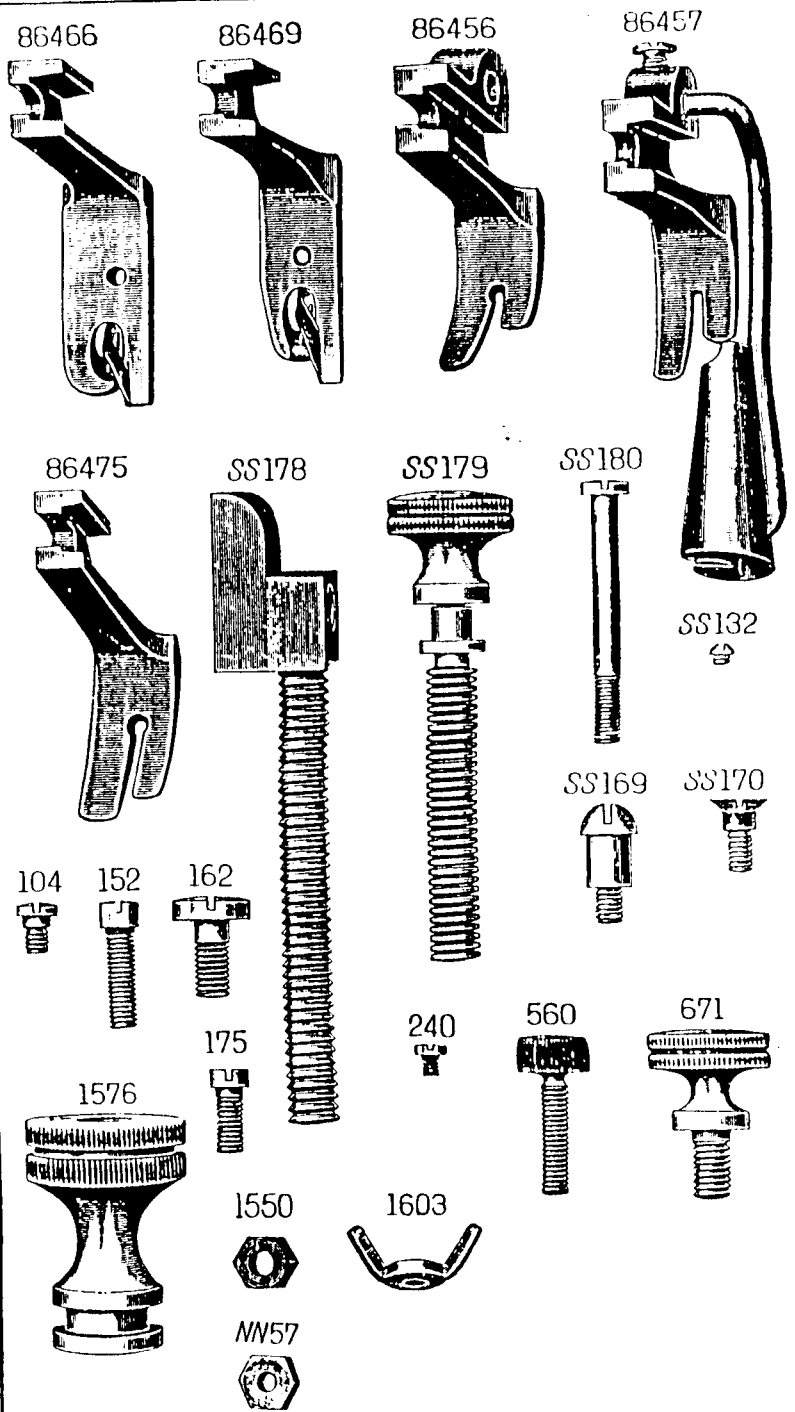

20340

12415

139623



12240

19372

5735

43947

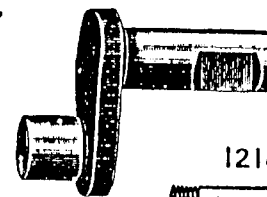
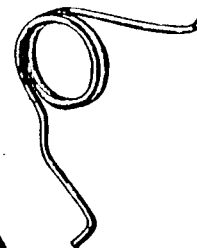

12149

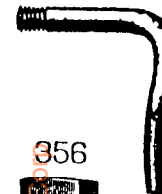

5601



12416



802



356



76

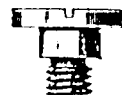

178



1507

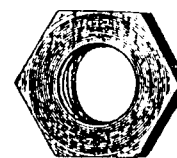

1521



From the library of: Diam...

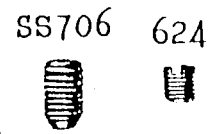
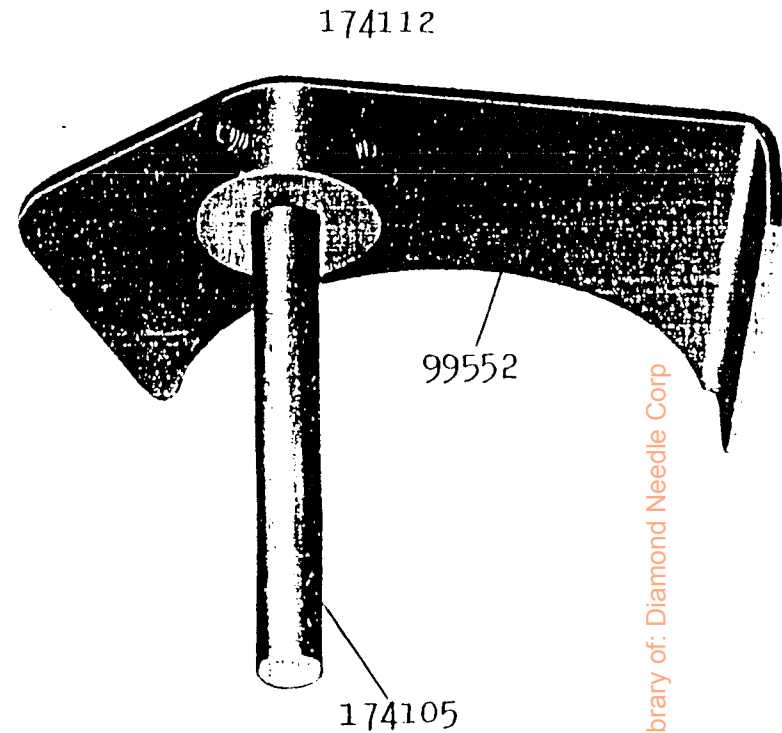
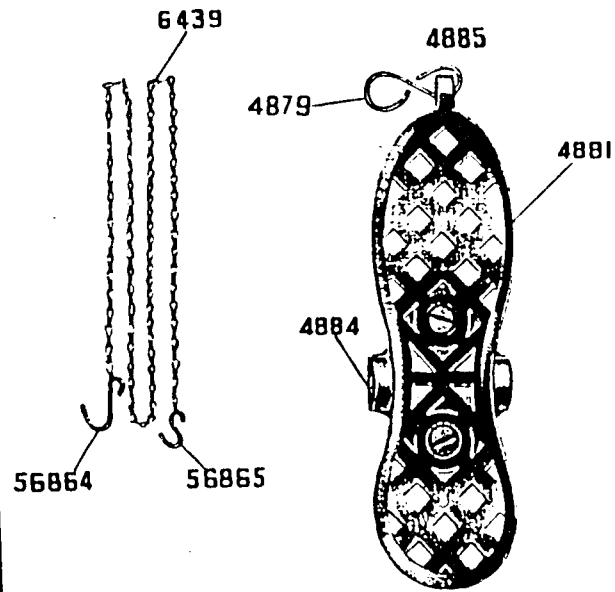
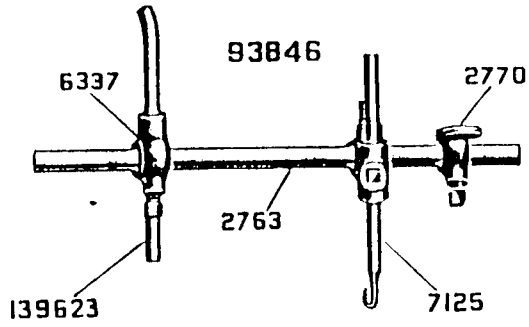

From the library of: Diamond Needle Corp

## No. 331K4 MACHINE PARTS

No.	Plate	
624(830)	2084	Belt Guard Set Screw
256(818)	2967	Clamp Stop Motion Clamp Screw
248(801)	2967	" " " " Stop Screw
171502	2967	" " " " Washer
139714	2967	" " " Flanged Bushing with two 140713(830)
140713(830)	2967	" " " " " Set Screw
139715	—	Clamp Stop Motion, complete, Nos. 248(801), 256(809), 139714 and 171502
20197	2967	Crank Connecting Rod with 20198, 125044 and two 896(830)
*20198	2967	" " " Cap
896(830)	2967	" " " " Screw
908(803)	2967	" " " Hinge Screw
1619(805)	2967	" " " " " Nut
125044	—	" " " Oil Pad (felt)
130716	—	Face Plate
44181	2973	" " Thread Guard (lower)
12150	—	" " " " ( " ) 44181 with 12152
12152	—	" " " " ( " ) Rivet
45874	2973	" " " " (upper)
139615	—	" " " " ( " ) 45874 with 125424
125424	—	" " " " ( " ) Rivet
139717	2973	Face Plate, complete, Nos. 12150, 139615 and 139716
51354(803)	2973	" " Screw
51224(818)	2973	" " Thumb Screw
12368	2969	Feed Bar
313(803)	2969	" " Screw Centre
56813	—	" " " " 313(803) with 1519(805) (2)
1510(803)	2969	" " " " Nut
139718	2967	Feed and Feed Lifting Eccentric with 446(830)
446(830)	2967	" " " " " Set Screw
127152	2967	" " " " " Sleeve
52165	2969	Feed Connecting Link
375(803)	2969	" " " Hinge Screw
1518(805)	2969	" " " " " Nut
52073	2968	" " " " Stud
50200(803)	2968	" " " " " Set Screw
149304	2969	Feed Dog, 13 teeth (12 teeth to the inch)
208(830)	2969	" " Screw (2)

## No. 331K4 MACHINE PARTS

No.	Plate	
139719	2969	Feed Forked Connection
375(803)	2969	" " " Hinge Screw
1518(809)	2969	" " " " " Nut
139720	2969	Feed Forked Connection, complete, Nos. 375(803), 1518(809), 52165 and 139719
44125	2969	Feed Lifting Rock Shaft
12376	2969	" " " " Crank with 157(813) and 1813
157(813)	2969	" " " " " Clamping Screw
44126	—	Feed Lifting Rock Shaft, complete, Nos. 12376 and 44125
43976	2967	Feed Lifting Rock Shaft Crank Connecting Rod with 43977, 125044 and two 966(805)
*43977	2967	" " Rock Shaft Crank Connecting Rod Cap
966(805)	2967	" " " " " " " " Screw
375(803)	2969	" " " " " " " Hinge Screw
1518(809)	2969	" " " " " " " Rod
125044	—	" " " " " " " Hinge Screw Nut
1904	2968	" " " " " " Crank Connecting Rod
1813	2969	" " " " " " Oil Pad (felt)
125060	—	" " " " " " Roller (roller only)
307(803)	2969	" " " " " " and Stud, Nos. 1904 and 125060
56814	—	" " " " " " Stud
1513(809)	2969	" " " " " " " " 307(803) with 1513(809) (2)
50338(803)	2968	" " " " " " Nut
50032	2968	" " " " " " Regulating Stud
50193(809)	2968	" " " " " " Head with 56033
56033	2968	" " " " " " Cap Screw
56034	2968	" " " " " " Stop Pin
56035	2968	" " " " " " Lock Pin
139754	2968	" " " " " " Spring
139755	—	" " " " " " Regulator with 50200(803)
140784(803)	2968	" " " " " " 139754 with 52073
174035	2968	" " " " " " Hinge Screw
174036	2968	" " " " " " Spring
161(805)	2968	" " " " " " Bracket (hook)
174037	2968	" " " " " " Screw
174038	—	" " " " " " Reversing Lever
174039	2968	" " " " " " 174037 with 624(830)
50591(803)	2968	" " " " " " Connection
1747(809)	2968	" " " " " " Screw (lower)
		" " " " " " ( " ) Nut



## No. 331K4 MACHINE PARTS

No.	Plate	
50591(803)	2968	Feed Reversing Lever Connection Screw (upper) ...
276160	2908	" " " Handle ...
200575(819)	2968	" " " " Screw ...
201529(819)	2968	" " " " " Nut ...
276159	2908	" " " Hinge Pin ...
624(830)	2968	" " " " " Set Screw ...
12379	2969	Feed Rock Shaft ...
29633	2969	" " " Crank with 157(813) ...
157(813)	2969	" " " " Clamping Screw ...
307(803)	2969	" " " Screw Centre ...
56814	—	" " " " " 307(803) with 1513(809)(2) ...
1513(809)	2969	" " " " " Nut ...
20333	—	Feed Rock Shaft, complete, Nos. 12379 and 29633 ...
12237	2980	Lifting Lever with 448(830) ...
12415	2981	" " Connecting Rod ...
12416(813)	2982	" " " " Joint ...
76(819)	2982	" " " " Hinge Screw ...
1521(805)	2982	" " " " Lock Nut ...
802(819)	2982	" " Hinge Screw ...
12241	2970	" " Link ...
706(804)	2970	" " Hinge Screw ...
12240	2982	" " Pin ...
448(830)	2967	" " Set Screw ...
139724	—	Machine Pulley (Disc) 'V' belt groove, (diam. of belt groove 2.9") with two 140713(830) for Latin America, Oriental and United States ...
139725	2967	Machine Pulley (Disc, Heavy Rim) 'V' belt groove (diam. of belt groove 2.9") with two 140713(830) ...
139726	—	Machine Pulley (Disc, Heavy Rim) Round Belt (diam. of belt groove 3") for use with 139715 ...
140713(830)	2967	Machine Pulley Set Screw ...
<i>NOTE.—No. 139725 is sent with this machine, unless otherwise specified on order.</i>		
16 x 87	—	Needle (Catalogue No. 2055) size 16 ...
139727	2908	Needle Bar (hollow) ...
139728	—	" " 139727 with 665(809), 143327 and 143328 ...
139729	2968	" " Bushing (lower) ...
1133(830)	2968	" " " ( " ) Set Screw ...
139730	2968	" " " (upper) ...
1133(830)	2968	" " " ( " ) Set Screw ...
12382	2968	" " Connecting Link with 794(805) ...
139731	—	" " " " 12382 with 139733 ...
794(805)	2968	" " " " Adjusting Screw ...
139765	2968	" " " Stud with 207(805) ...
139733	—	" " " " 139765 with 1904 ...
207(805)	2968	" " " Clamping Screw ...
1904	2968	" " " Roller (roller only) ...

## No. 331K4 MACHINE PARTS

No.	Plate	
139734	2967	Needle Bar Crank with 1065(830) ...
1065(830)	2967	" " " Position Screw ...
143327	2968	" " Thread Guard ...
665(809)	2968	" " " " Screw ...
143328	2968	Needle Clamp with 140119(830) ...
140119(830)	2968	" " Screw ...
139735	2972	Oscillating Rock Shaft ...
12388	2972	" " " Hinge Pin ...
448(830)	2972	" " " " " Set Screw ...
4784	—	" " " Oil Pad ...
139736	—	Oscillating Rock Shaft, complete, Nos. 4784, 12388 and 139735 ...
12389	2972	Oscillating Shaft ...
44013	—	" " 12389 with 2049, 12394 and 19447 ...
19496	2972	" " Crank ...
3093	2972	" " " Pin ...
457(830)	2976	" " " Set Screw ...
19448	2972	" " " Slide Block ...
226(804)	2976	" " " " " Cap Screw ...
12424	2976	" " " " " Washer ...
988(803)	—	" " " " " Screw Stud ...
1518(809)	2976	" " " " " Nut ...
19449	—	" " " " " complete, Nos. 226(804), 988(803), 12424 and 19448 ...
*19447	—	Oscillating Shaft Crank, complete, Nos. 457(830), 1518(809), 19449 and 19496 ...
12391	2971	Presser Bar (hollow) ...
20059	2970	" " Guide Bracket with 453(830) ...
453(830)	2970	" " " " Set Screw ...
52016	2971	" " Lifter ...
689(803)	2971	" " " Screw ...
1520(813)	2971	" " " " Nut ...
12327	2971	" " Lifting and Releasing Lever Bracket ...
11167	2970	" " Spring (light) ...
12139	—	" " " (medium) ...
20023	—	" " " (heavy) ...
<i>NOTE.—No. 11167 is sent with this Machine, unless otherwise specified on order.</i>		
11170	2970	Presser Bar Spring Washer ...
12144	2970	Presser Foot ...
190(809)	2970	" " Screw ...
688(809)	2970	Pressure Regulating Thumb Screw ...

From the library of: Diamond Needle Corp

## No. 331K4 MACHINE PARTS

No.	Plate	
2996	2972	Shuttle Bobbin ... ..
15141	2972	" " Case Hinge, Nos. 2973, 2974 and 15140 ...
15140	2972	" " " Latch ... ..
2973	2972	" " " " Lever ... ..
2974	2972	" " " " " Fulcrum Pin ... ..
2975	2972	" " " " " Spring ... ..
592(805)	2976	" " " " " Stop Screw ... ..
24412	2972	" " " " " Position Plate ... ..
391(813)	2972	" " " " " " Screw ... ..
62740	2972	Shuttle Bobbin Case with 591(806), 592(805), 2975, 15141 and 15278
12393	2972	Shuttle Body ... ..
591(806)	2976	" Tension Regulating Screw ... ..
15278	2972	" " Spring ... ..
19292	2972	Shuttle, 1 1/4" diam., complete, Nos. 2996, 12393 and 62740
*12394	2972	Shuttle Driver ... ..
12444	—	" " 12394 with two 1266(803) (for Agents only)
2049	2972	" " Pin ... ..
1266(803)	2976	" " Set Screw ... ..
2531	2972	Shuttle Race Back... ..
2532	2972	" " " Position Pin ... ..
2533	2972	" " " Spring ... ..
907(804)	2972	" " " " " Screw ... ..
24413	—	" " " Body ... ..
24962	—	" " " 24413 with 24414, two each 1053(804) and 2532
24414	2972	" " Cap ... ..
1053(804)	2976	" " " Screw ... ..
24415	2972	Shuttle Race, complete, Nos. 907(804), 2531, 2533, 24412, 24962 and two 391(813)
145(805)	2972	Shuttle Race Screw (2) ... ..
12431(819)	2970	Shuttle Race Slide ... ..
4307	2970	" " " Spring ... ..
725(819)	2970	" " " " " Screw ... ..
12432	2970	Shuttle Race Slide, complete, Nos. 4307, 12431(819) and two 725(819)
20060	2974	Slack Thread Regulator ... ..
225(806)	2974	" " " Adjusting Screw ... ..
2102	2974	Tension Disc ... ..
1560(803)	2974	" Regulating Thumb Nut ... ..
147151	2974	" Releasing Disc ... ..
43944	2974	" " Lever ... ..
12398	2974	" " " Hinge Pin ... ..
12329	2974	" " " Spring ... ..
32574	2974	" " " Pin ... ..

## No. 331K4 MACHINE PARTS

No.	Plate	
*50327(803)	2974	Tension Screw Stud ... ..
44141	—	" " " 50327(803) with 1560(803) ... ..
147152	2974	" Spring ... ..
139738	—	Tension, complete, Nos. 7336, 32574, 43946, 44141, 147151, 147152 and two 2102 ... ..
52454	2976	Thread Retainer ... ..
624(830)	2976	" " Set Screw ... ..
12404	2968	Thread Take-up Crank ... ..
3094	2968	" " " Wedge ... ..
5750	—	" " " " 3094 with 690(805) ... ..
690(805)	2968	" " " " " Screw ... ..
139740	2968	Thread Take-up Lever with 139742 ... ..
775(805)	2968	" " " Cap Screw ... ..
139766	2968	" " " Guard ... ..
335(813)	2968	" " " " " Screw (2) ... ..
52023	2968	" " " Hinge Pin ... ..
139741	2968	" " " Link ... ..
166024	2968	" " " " " Hinge Pin ... ..
435(830)	2968	" " " " " " Set Screw ... ..
139742	2968	" " " " " Thread Eyelet Bushing ... ..
43946	2974	Thread Take-up Spring ... ..
7336	2974	" " " Regulator ... ..
448(830)	2967	" " " " " Set Screw ... ..
139743	—	Thread Take-up, complete, Nos. 775(805), 12404, 52023, 139731, 139740, 139741 and 166024 ... ..
12414	2970	Throat Plate (large needle hole) ... ..
691(850)	2970	" " " Screw (2) ... ..
139637	—	Drip Pan with four 1" wire nails ... ..
15405	—	Class Plate Rivet ... ..
15405	—	Trademark Rivet ... ..

 From the library of: **Diamond Needle Corp.**